

DESCRIPTION

The MXLFAV025024V06A is a constant voltage LED driver for indoor or outdoor applications. Its wide range input voltage and small form factor, makes it suitable for use in both industrial and domestic environments.

FEATURES

- 25W max output power
- Constant voltage output
- Dimming 0 - 10V
- High PF
- Low THD
- Wide input range 120 – 277VAC



ELECTRICAL SPECIFICATIONS

Parameter	Nominal	Maximum	Units
Input voltage	120 - 277	120 - 277	VAC
Output voltage	12	12	VDC
Input current	0.26 @120V; 0.12@277V	-	Amp
Output current	0.10	1.04	Amp
Leakage current	0.75	-	mA
Output power	25	25	W
Frequency	50 / 60	-	Hz
Power factor	0.95	-	-
THD	10	-	%
Efficiency	83	-	%
Protections	OVP, OTP, SC	-	-

OPERATING SPECIFICATIONS

Parameter	Value	Units
Operating temperature	-40 to +90	°C
Operating humidity	IP66	-
Isolation voltage (Input to Output)	1860	V

*The specifications are subject to change without notice.

SAFETY AND STANDARD COMPLIANCE

UL compliance

USR Class2

CONNECTION WIRING

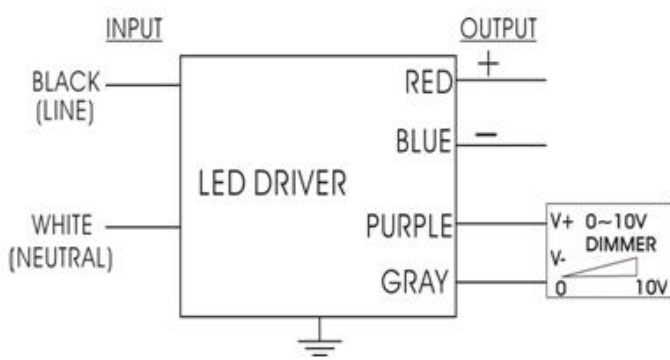

DIMENSIONS

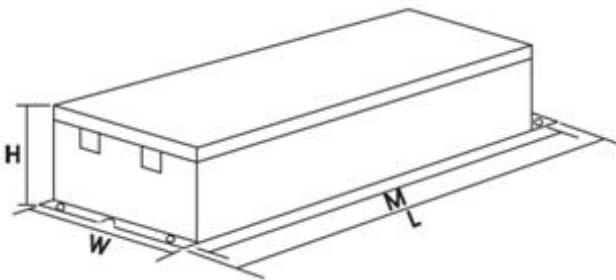

Length(L)	Width(W)	Height(H)	Mounting(M)
24.1cm	4.3cm	2.9cm	22.6cm
9.5"	1.7"	1.14"	8.9"

*The specifications are subject to change without notice.



INSPIRING TRUST

1651 E. St. Andrew Place
 Santa Ana, CA 92705 USA
 Tel. (714) 258-0263
 Fax. (714) 258-8108
www.mxlightforce.com